

Guide line to check and repair the safety equipment of the Robusta Plus Sliding Gate ver. 1.0

Contents

1. Technical data of the Robusta Plus Sliding gate.....	1
2. Checklist in case of failure Drive unit C720 / 721.....	2
3. Checklist in case of failure Drive unit C746 / 844.....	3
4. Manual for to check the safety devices of the sliding gates guiding post / lock post.....	4
5. AERF System (Wireless Band).....	9
6. Installation of resistive safety strip at the front of the wing of Robusta Plus sliding gate.....	11
6.1 Table of required resistive safety strip (SAP code) according the height of the gate.....	11
6.2 Procedure to connect resistance safety strip to the AERF system.....	12
Electrical drawing safety strips E780.....	14
Electrical drawing photocells E780.....	15

1. Technical data of the Robusta Plus Sliding gate

Type of FAAC unit: _____ Dimension: _____ Construction year: _____

2. Checklist in case of failure Drive unit C720 / 721

Error analysis by using the status LEDs

checked

- | | |
|--|--|
| No LED active | Check the fuse of the steering, if necessary replace it. <input type="checkbox"/> |
| LED BUS is blinking or off | LED is blinking: Photocells are working <input type="checkbox"/>

LED is off: Photocells doesn't work, check wire connection, if necessary replace the photocell. |
| LED FSW OP is off | Safety strip „OPEN“ doesn't work. Check OSE-S unit (Connection box guiding post) (Status LED must be off) if status LED is active, check light beam sensors of the safety edge, if necessary replace the OSE-S unit. <input type="checkbox"/> |
| LED FSW CL is off | Safety strip „close“ doesn't work. Check OSE-S unit (Connection box guiding post) (Status LED must be off) if status LED is active, check light beam sensors of the safety edge, if necessary replace the OSE-S unit. <input type="checkbox"/> |
| LED Stop is off | Check the wire connection of the connection bar J3. Short circuit bridge must be connected from 4 to 6. <input type="checkbox"/> |
| LED status is ok, but motor doesn't work | The drive is unlocked, the wing can move with hand, drive must be locked. <input type="checkbox"/> |
| Drive wants to start, wing does not move | Unlock the drive, if necessary disassembling of the drive, move the wing with hand. Wing must be movable without resistance the whole distance in both directions. <input type="checkbox"/> |

Warning light does not blink

Check the bulb, if necessary replace it. Lamp stays always on; replace the board of the warning light.



3. Checklist in case of failure Drive unit C746 / 844

Error analysis by using the status LEDs

checked

No LED active

Check the fuse of the steering, if necessary replace it.

LED Stop is of

Check the wire connection to the connector of the steering . Short circuit wire must be connected from connector 5 to 7.

LED FSW OP is off

Check the wire connection of the connection bar J1. Short circuit wire must be connected from connector 3 to 11.

LED FSW CL is off

Photocells doesn't work, check wire connection if necessary replace the photocell.

LED SAVE is off

Activate the gate till movement, LED SAVE must become active.

Otherwise

Check the wireless band (Transmitter receiver) of the safety edge of the wing, if necessary exchange the batteries. If the safety edge of the wing is working, OK.

Otherwise

Check the light beam sensors of the safety edge of the wing, if necessary replace them.

- | | | |
|------------------------------|---|--------------------------|
| Otherwise | Check OSE-S unit (Connection box inside the guiding post) (Status LED must be off) if status LED is on check the sensors of the safety edge, if necessary replace the OSE-S unit. | <input type="checkbox"/> |
| Warning light does not blink | Check the bulb, if necessary replace it. Lamp stays always on; replace the board of the warning light. | <input type="checkbox"/> |

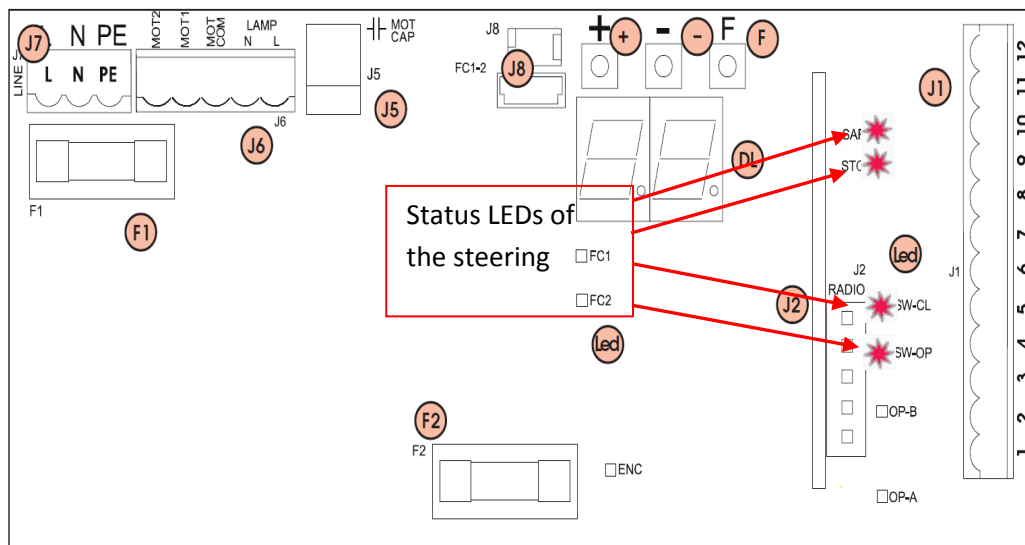

IMPORTANT

FC1 and FC2 are “end indicators”: when the gate is half way open, both LED’s will be ON, when gate is open or close, only one of both will be ON.

[4. Manual for to check the safety devices of the sliding gates guiding post / lock post](#)

Type of safety devices:

- 4.1 Safety edge
- 4.2 Photocell

4.1 Safety edges

For 1 safety edge is required:

1 x rubber profile

1 x Light beam (photocell assembled on top and bottom of the rubber profile)

1 x OSE unit

Light beam sensor (top and bottom of the rubber profile)

OSE signal processing (Yellow item)

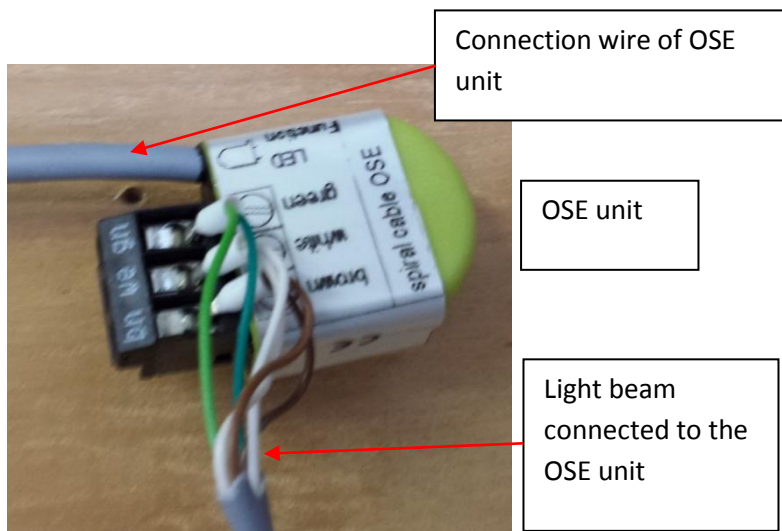

The light beam will be connected to the OSE unit. (Photo) The color code of the wires is written to the OSE unit.

The light beam consists of transmitter and receiver. Both items are equipped with the same cable and the same colored wires. (White, brown, green)

The OSE unit is equipped with a red LED. If power is “on”, and everything is OK, the red LED is “off”.

It means the safety edge is in work and nothing is detecting / touching the edge.

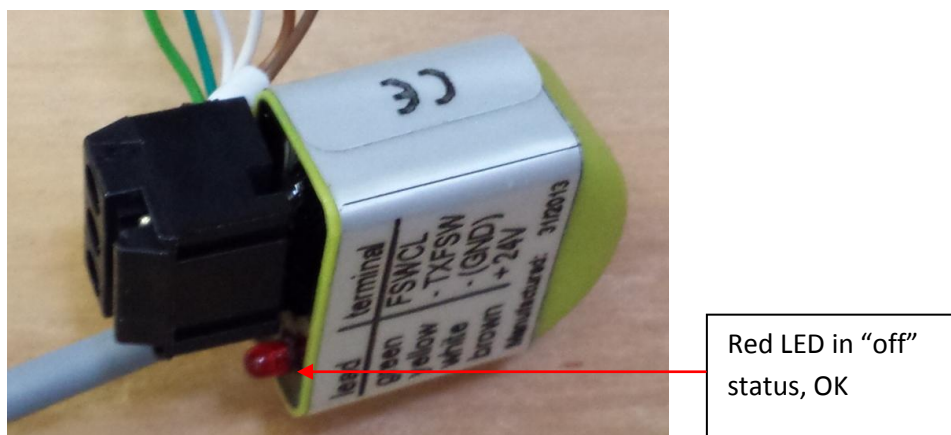

The connection cable of the OSE unit has the follow wires:

Brown: Power, plus (24V from controller)

White: Power, minus (0V from controller)

Yellow: Signal (in loop with the AERF receiver, connector 8) (electrical drawing page 15)

Green: Signal (input of the controller, connector 6)

The photo below shows the “possible” connection of 2 OSE units, the signal wires of both units will connected in line (serial) (Green, unit 1, from controller; yellow, unit 1, to green of unit 2; yellow from unit 2 back to controller)

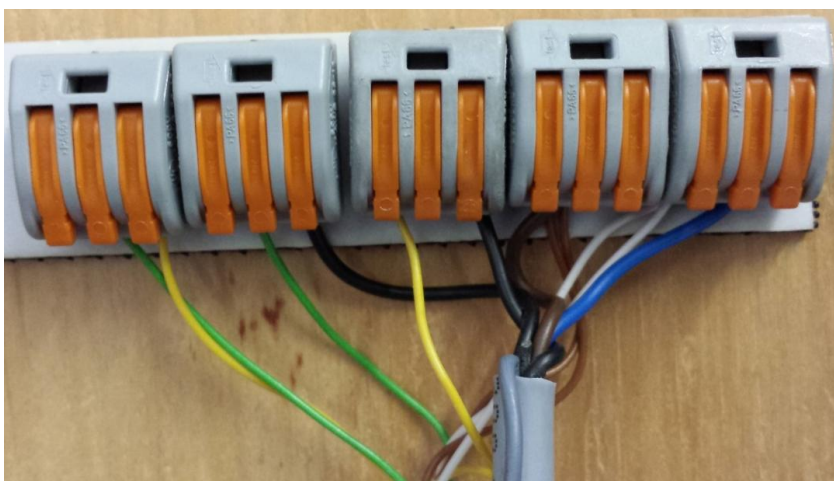

If something happen, the red LED will be “on”.

The reason for that could be the rubber profile of the safety edge is bent or something is pushing on it.

If nothing touches the safety edge and the LED is “on”, one item is fault.

Either the OSE unit or the light beam of the safety edge.

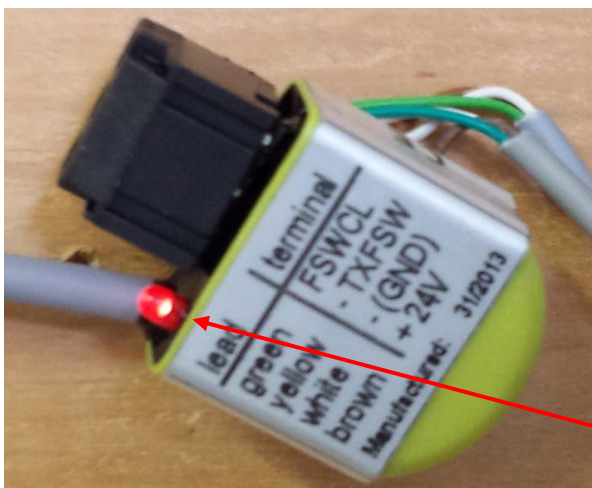

Red LED in “ON” status

If 2 OSE units connected in line (serial) and one of it is activated, the other one will activated automatically.

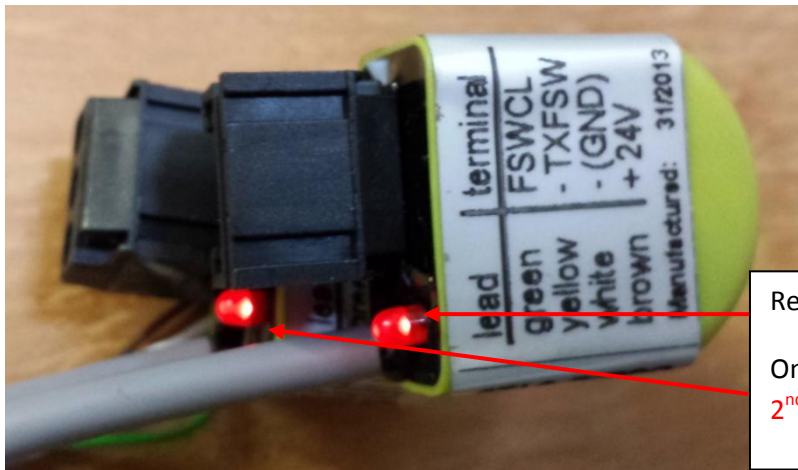

Red LED in "ON" status;
One OSE unit is activated or fault, the 2nd one is active too.

How to solve the problem:

Take a new light beam and connect to the OSE unit. (SAP code 1017486)

If the LED goes off, OK, if not,

Exchange the OSE unit. (SAP code 1017448)

4.2 Photocells

The photocells consists of 1 transmitter and one receiver
Transmitter on the photos below

Electrical drawing page 16

With plastic cap



Without plastic cap

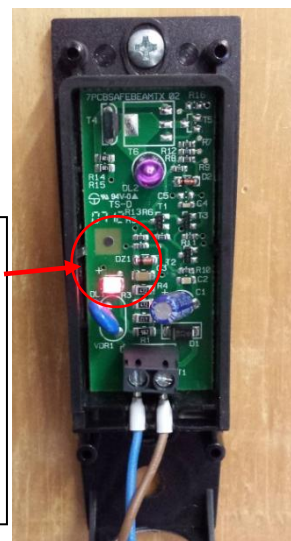

LED activ, transmitter is working

If the LED is off, power is off or transmitter is fault

Receiver on the photos below

Receiver in work

With plastic cap

Without plastic cap

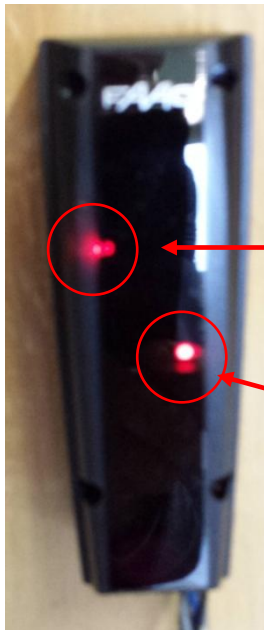

The upper LED is ON, the signal from transmitter will received, system is working

This LED shows the power for the receiver is OK.
If it is off, the power is missing / fault

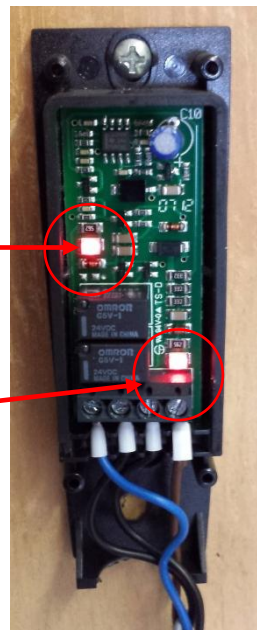

Receiver fault, signal (light beam) from transmitter is missing.

With plastic cap

Without plastic cap

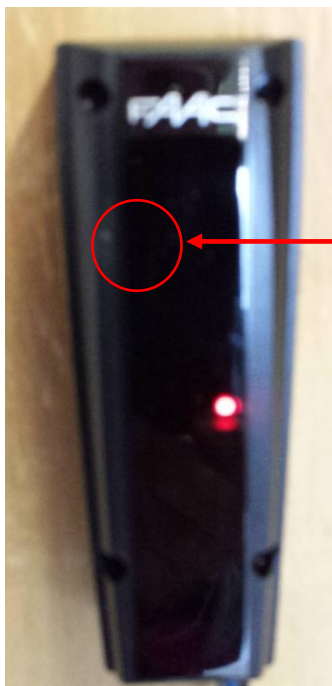

The upper LED is off,
Signal from transmitter is missing / will not received

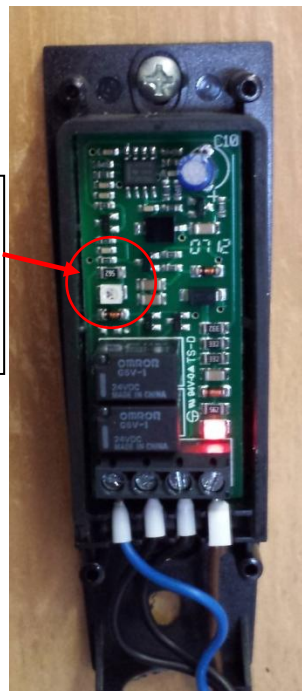

Important, please note:

Without the plastic cap the working distance of the photocells are very low, about 2m only. For to check it is required to assemble the plastic cap. A lens is inside the plastic cap for to increase the range.

Connection plan of the photocells:

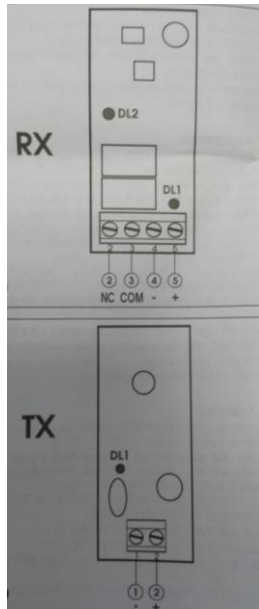

5. AERF System (Wireless Band)

AERF version 2.F.I

If the AERF system doesn't work, please check the battery of the transmitter (In front of the wing) at first. Change the FAAC drive unit to the manual mode and open the gate with hand. Push the safety strip on top of the wing, the relay inside the receiver should work if the gate is open. (Small distance between transmitter and receiver) If so, the batteries are empty and they must exchange. Use batteries with a power of 3.6v only!! (**SAP code for battery 1017580**)

If the system doesn't work, choose the DIP settings of transmitter and receiver as described in point 5.2.

If the system is working, change back the DIP setting (point 5.1.1) and reprogram the system.

Attention:

Before the reprogramming procedure push the button on the controller board of the receiver (item on the FAAC drive unit) and hold on pushing till a triple beep comes. Release the button and disconnect the connection plug of the receiver for 10 seconds. Reconnect it and follow point 5.1.2

5.1 Used with the drive unit 746/844 with firmware 1Q

This version is foreseen of a sticker: NEW VERSION 1Q, put on the transformer to the left of the controller

5.1.1 DIP-switch SETTINGS

Transmitter (component at the wing):

Switch 1: off

Switch 2: on

Switch 3: off

Receiver (component at the drive unit):

Switch 1 on

Switch 2: off

Switch 3: on

Switch 4: on

Switch 5: on

5.1.2 Programming the activation time

ATTENTION: First program the activation time, then program transmitters to the receiver

1. Press PROG button for 1.5 sec.
2. On hearing the acoustic signal stop pressing as the receiver will be logged into the memorizing code process.
3. Prog. LED will be turned on indicating that you are programming transmitters.
4. Press PROG button again for 1.5 sec.
5. Prog. LED will flash indicating that you are programming power supply time.
6. Waiting time. You must wait for time you need for having the power supply for the OSE.
7. Press PROG button again for 1.5 sec. receiver will exit the process and power supply time will be memorized.

IMPORTANT: times below 10 seconds will not memorize.

Table for activation times

speed: 9 [m/min]

free passage [m] or open - or close time [h:m:s] (1/2cycle)	3	4	5	6	7	8	9	10	11	12	13	14
activation time [h:m:s]	00:00:20	00:00:27	00:00:33	00:00:40	00:00:47	00:00:53	00:01:00	00:01:07	00:01:13	00:01:20	00:01:27	00:01:33
	00:00:40	00:00:53	00:01:07	00:01:20	00:01:33	00:01:47	00:02:00	00:02:13	00:02:27	00:02:40	00:02:53	00:03:07

5.1.3 Go in 'advanced programming mode' on motor controller and set FS and SA on 'Y'

5.2 Used with drive unit 746/844 with firmware older then 1Q

Drive unit 746 / 844 is **not** foreseen of a label

5.2.1 Setting DIP switch

Transmitter (component on the wing):

- Switch 1 on
- Switch 2: off
- Switch 3: off

Receiver (part of the drive unit):

- Switch 1 on
- Switch 2: off
- Switch 3: on
- Switch 4: off
- Switch 5 off

5.2.2 The activation time is not programmed, a battery pack is needed!

5.2.3 Go in 'advanced programming mode' on motor controller and set FS on 'Y' (SA is not available with this firmware version)

6. Installation of resistive safety strip at the front of the wing of Robusta Plus sliding gate

If the AERF system doesn't work as described in point 5.1, the light beam safety strip in front of the wing can be changed to a resistive safety edge.

6.1 Table of required resistive safety strip (SAP code) according the height of the gate

Nominal [m]	Height of wing [mm]	SAP CODE of safety strip
1	967	1006184
1,2	1167	1006185
1,5	1467	1006186
1,7	1667	1006187
2	1967	1006186
2,4	2367	1006190

These safety strips codes are including the aluminum profile to fix on top of the gate's wing.

IMPORTANT NOTE:

Replacing the optical resistance safety strip at the front of the wing by a resistance safety strip is under responsibility of the installer. The present instruction guideline is given by Betafence on an informative basis only.

6.2 Procedure to connect resistance safety strip to the AERF system

6.1 Transmitter:

The resistive safety strip has to connect to connector 1 and 2 of the transmitter.



The photo shows the wire of the safety strip connected to the AERF transmitter

The dip switch of the transmitter has to be changed to the follow position:

DIP 1: ON

DIP 2: OFF

DIP 3: OFF



6.2 Receiver:

Two of the wire connections have to be changed.

The grey wire (connector 6) has changed to connector 3

The blue wire (connector 8) has changed to connector 5

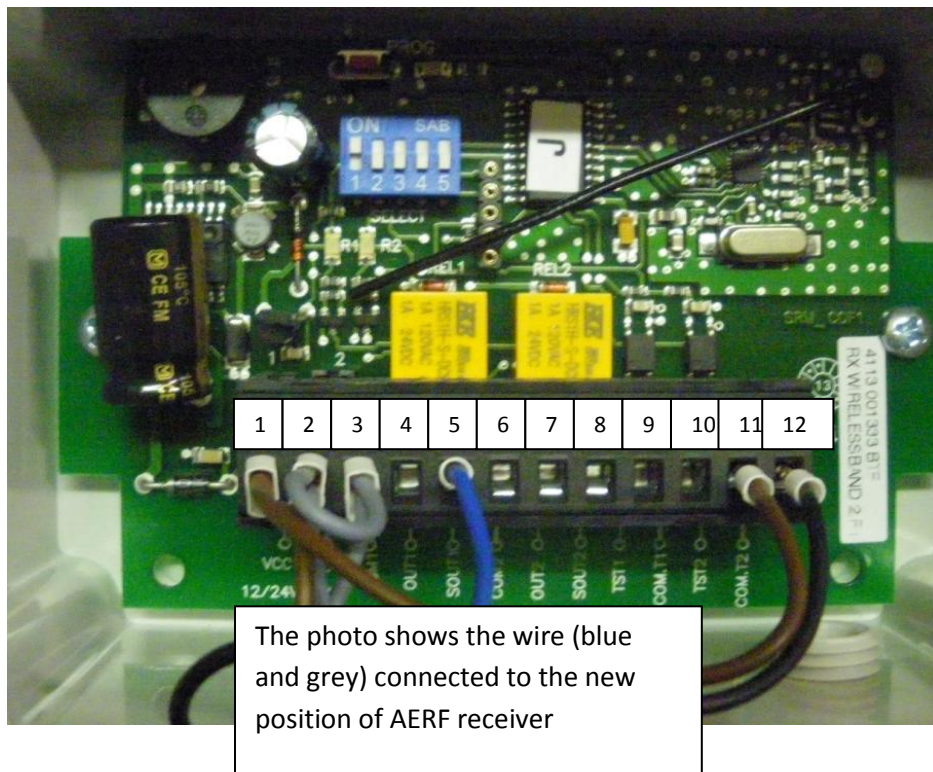

The dip switch of the receiver has to be changed to the follow position:

- DIP 1: ON
- DIP 2: OFF
- DIP 3: OFF
- DIP 4: OFF
- DIP 5: OFF

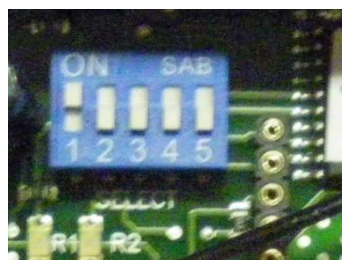

6.3 FAAC controller (Motor):

Open the programming menu, 2nd level. (F and + button)

The parameter "**FS**" has changed to "no"

If the Software is without the parameter "**FS**" nothing is to do

With these settings the AERF system stays always active (with low battery consumption).

Electrical drawing safety strips E780

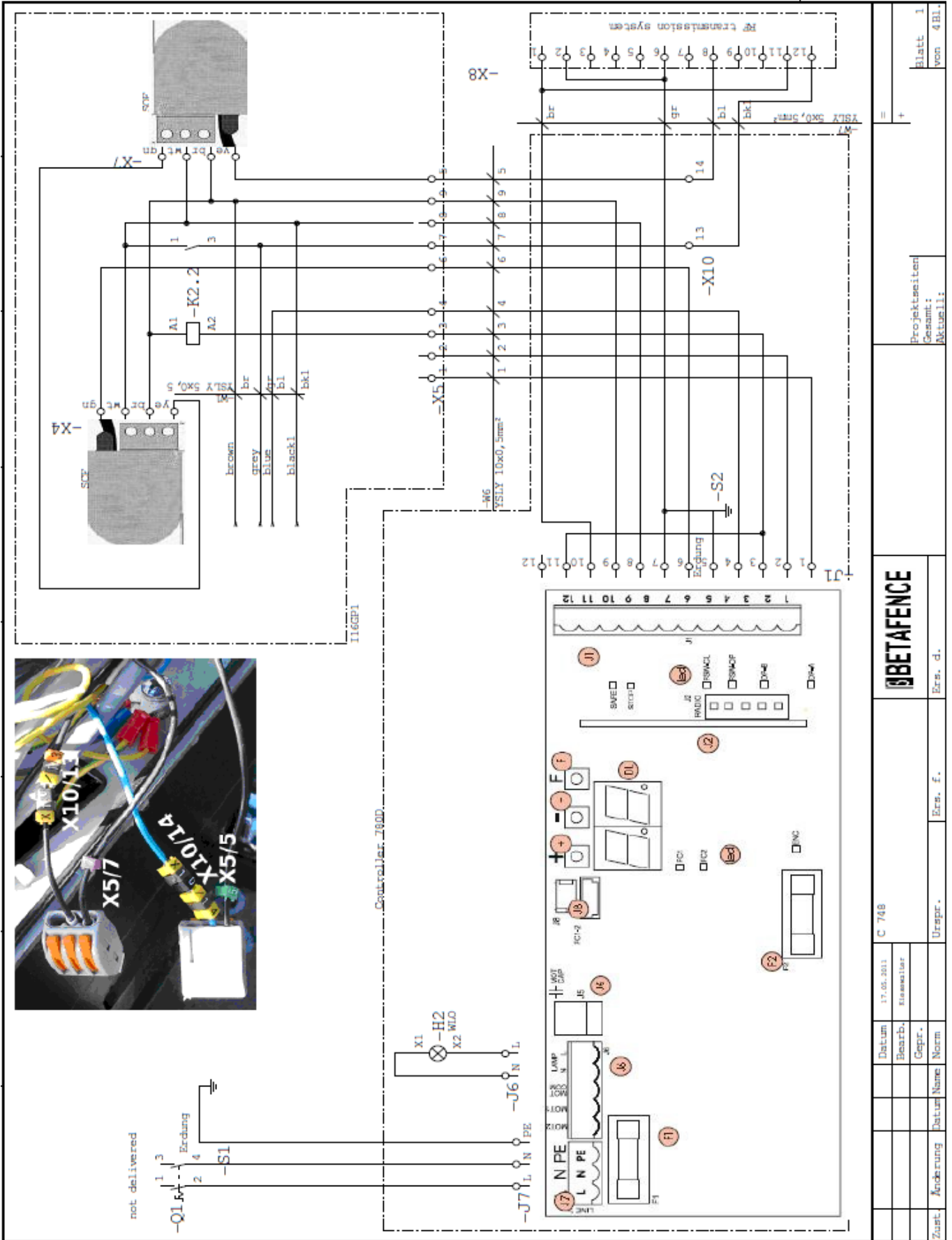

Projektseiten Gesamt: Aktuell:	Blatt 1 von 4 Bl.
--------------------------------------	----------------------

BETAFENCE	
Ers. d.	Ers. f.
Urspr.	Urspr.
Datum 17.05.2013	C 748
Bearb. Kiesewalter	
Gepr.	
Datum Name Norm	
Zust.	

Electrical drawing photocells E780

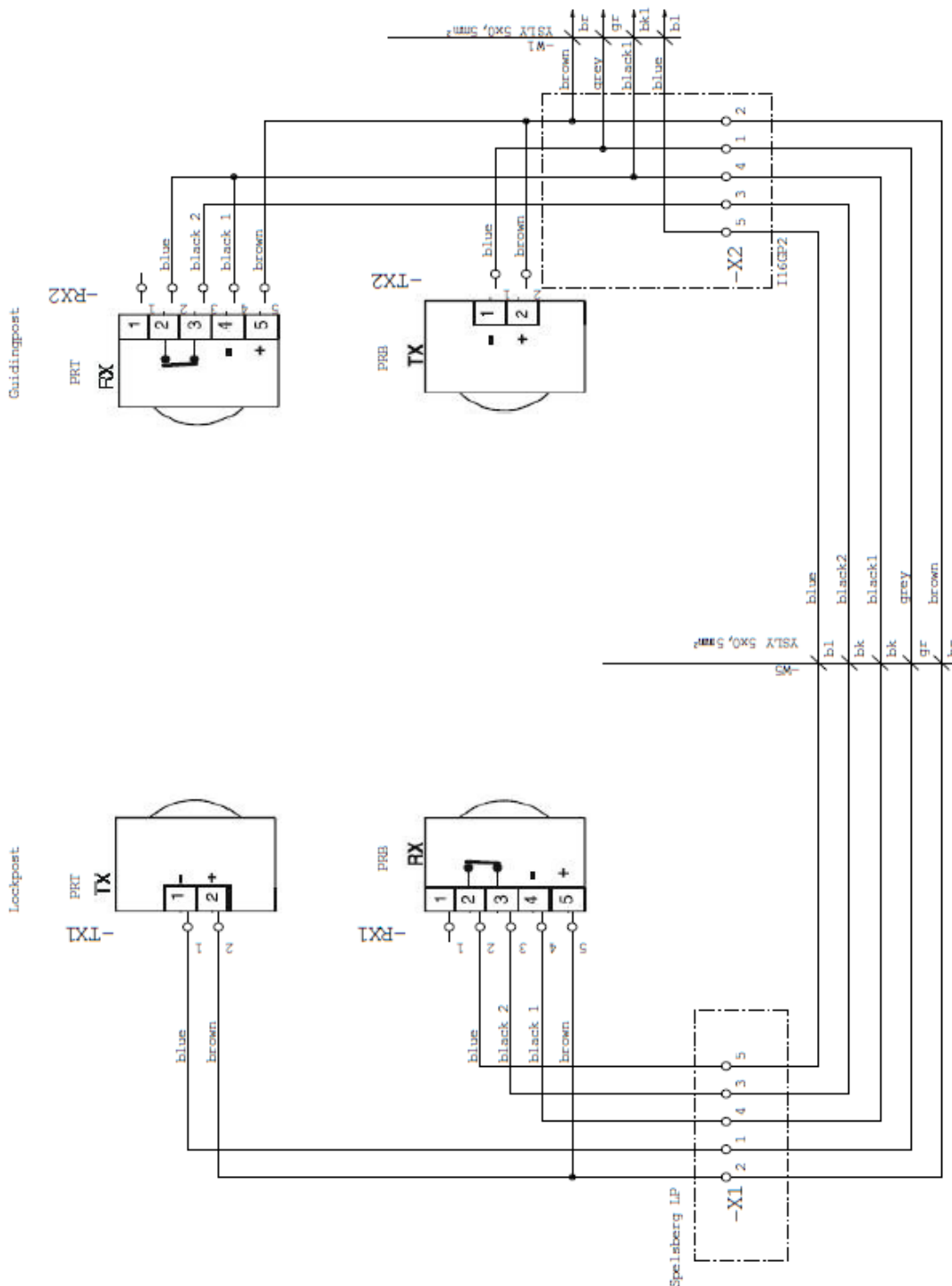

Zust.		Änderung		Datum		Name		Urspr.		Ers. f.		Ers. d.				Projektsseiten Gesamt: Aktuell:		Blatt 2 von 4 Bl.	
					10.08.2013		Kiesewalter												
C 748																			